

# CL34 Regulator

## Commercial and Industrial Regulator

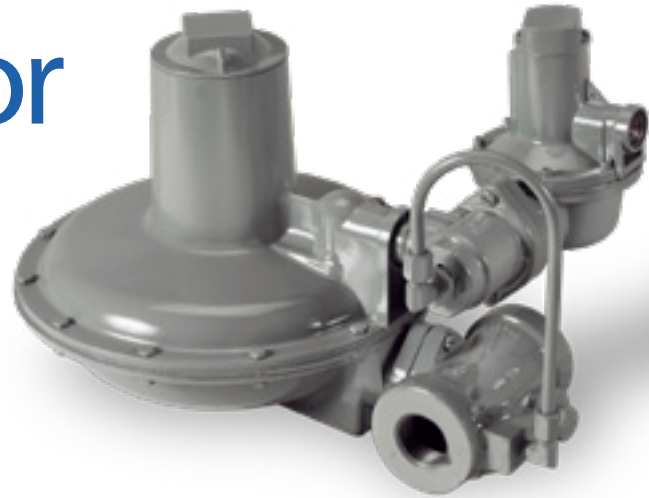

Appropriate for commercial and industrial applications where very accurate pressure control is required such as “fixed-factor” metering applications or large boiler and furnace applications.

## Description

The CL34 is a constant pressure loaded regulator for use where closer PSIG to PSIG regulation is desired than can be obtained from conventional spring loaded regulators. Since it requires an inlet pressure supply of only 1/2 PSIG above outlet pressure, this unit can be used where demand type loading will not meet the low pressure differential.

### » CL34

Internal registration  
(no control line required)

### » CL34-M

Equipped with closed-throat and control line tap for remote downstream control (external registration)

### » CL34-IM

Equipped with an internal monitor orifice; internal registration (no control line required)

### » CL34-IMV

Equipped with an internal monitor orifice plus vent hole option for monitor warning indication; Internal Registration (no control line required)

All versions are available with either -1 or -2 pilot:

- » #1 pilot for 5” w.c. to 5 PSIG outlet pressure (Model Name Example: CL34-1)
- » #2 pilot for 1 PSIG to 60 PSIG outlet pressure (Model Name Example: CL34-2)

## Benefits

- » Economical
- » Light weight
- » Accurate pressure control for “fixed-factor” measurement applications
- » No special start-up procedures required

- » Internal monitor version eliminates the need for external relief valves or separate monitoring devices
- » No special tools required for outlet pressure adjustment
- » No minimum differential pressure requirement

## Features

- » Constant loaded pilot design (“fixed-factor” pressure control)
- » Interchangeable brass orifice
- » 78 in<sup>2</sup> of diaphragm area
- » Spring-loaded pilot internal relief valve assembly
- » Field interchangeable pilot adjustment spring
- » Controlled internal bleed hole eliminates pulsation
- » Wide range of valve body sizes including NPT and flange connections
- » 16 different available assembly positions

# SHIPPING WEIGHT

One regulator per box    Box weight: 34 lbs. (NPT) 42 lbs. (Flange)

## CL34 DIMENSIONS (INCHES)

Valve Body Type	A	B	C	D	E	F	G	H	I
NPT (all sizes)	19-5/16	12-3/4	7-5/16	8-11/16	10	4-5/16	4-7/8	5-3/4	2-7/8
Flanged (all sizes)	20-1/2	12-3/4	7-5/16	8-11/16	10	4-5/16	4-7/8	10	5

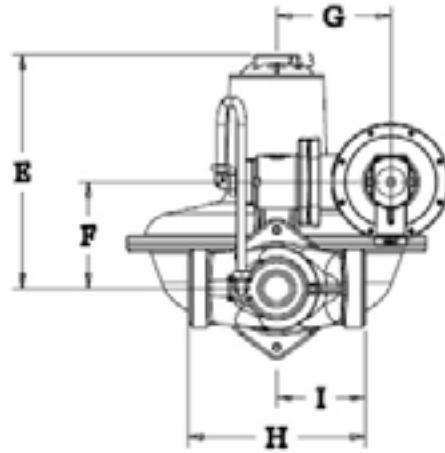
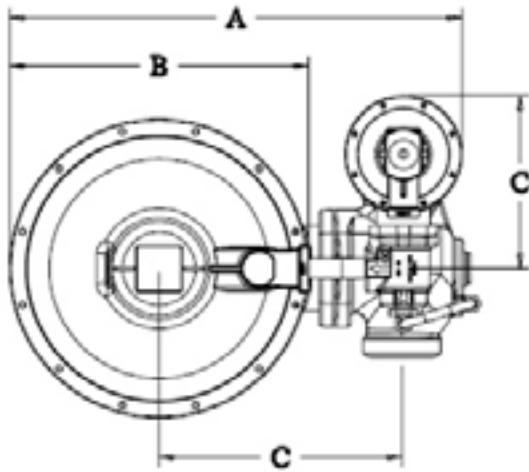

## OPERATIONAL SCHEMATIC

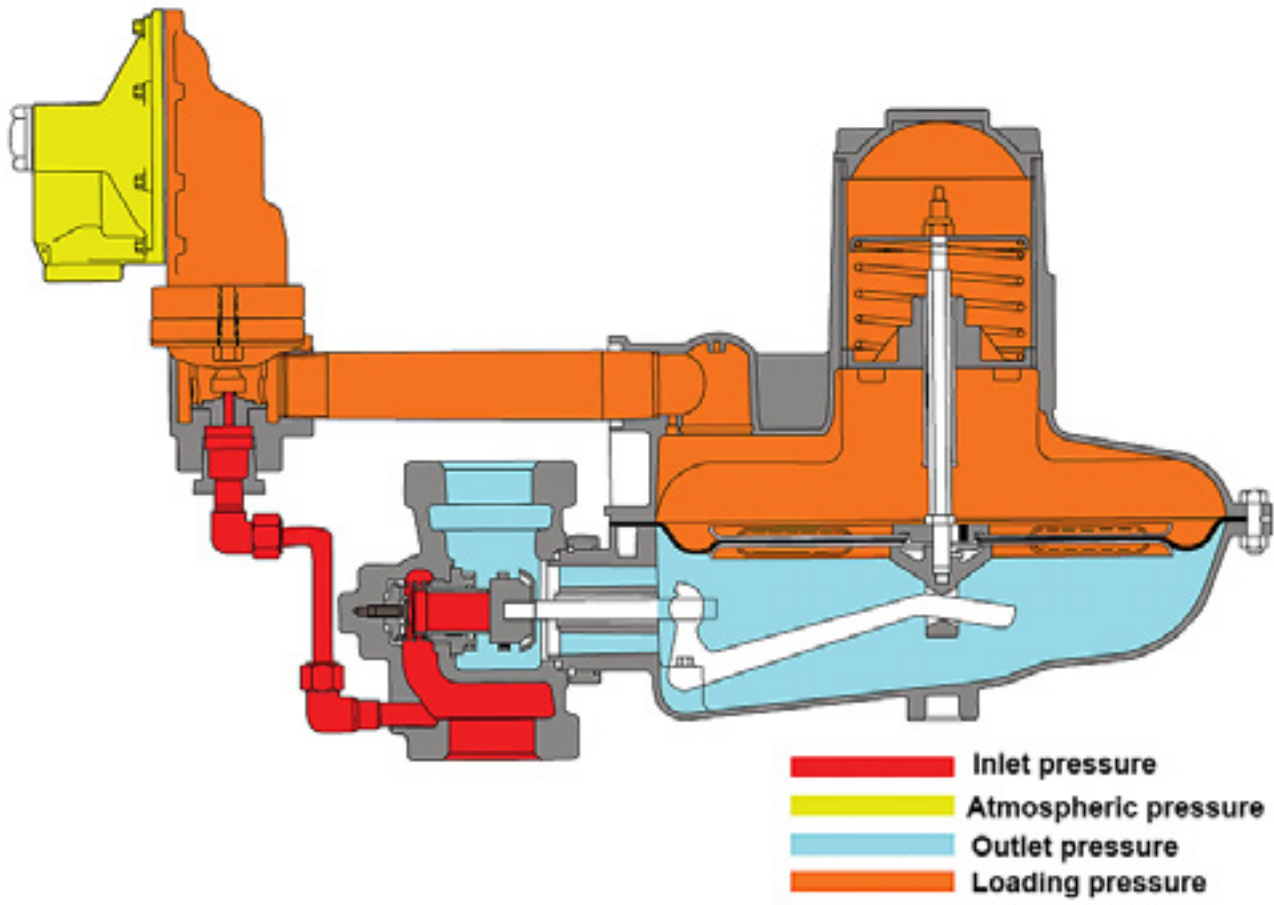

Note Valve shown in closed position.

## SPRING DATA, SPRING COLOR OUTLET PRESSURE RANGE

Max. Differential Pressure Across Orifice PSIG (BAR)*												
Closing Spring Color	7/8"		3/4"		5/8"		1/2"		3/8"		1/4"	
Orange	18	(1.2)	21	(1.4)	30	(2.1)	50	(3.4)	75	(5.2)	200	(13.8)
Brown	40	(2.8)	60	(4.1)	90	(6.2)	140	(9.7)	275	(19.0)		
Green**	55	(3.8)	80	(5.5)	120	(8.3)	200	(13.8)				
Black	115	(7.9)	150	(10.3)	245	(16.9)						

\*The maximum recommended pressure differential and closing spring is based on 2:1 safety factor.

\*\* IM versions available with Green Closing spring only.

## MODELS CL34-1 & CL34-1IM

Pilot Spring Color	Closing Spring Color PSIG (mbar)*			
	Orange	Brown	Green	Black
Green/White	4 - 6 in. w.c. (10 - 15 mbar)	---	---	---
Blue/White	7 - 13 in. w.c. (17 - 32 mbar)	5 - 10 in. w.c. (12 - 25 mbar)	5 - 9 in. w.c. (12 - 24 mbar)	---
Dark Green	13 - 17 in. w.c. (32 - 42 mbar)	12 - 13 in. w.c. (30 - 32 mbar)	---	---
Silver/White	0.5 - 1.25 (.03 - .08)	0.5 - 1.1 (.03 - .08)	.05 - 1 (.03 - .07)	6 - 19 in. w.c. (15 - 47 mbar)
Yellow/White	1.4 - 2.1 (.1 - .14)	1.4 - 2.0 (.1 - .14)	1.3 - 1.9 (.09 - .13)	1.1 - 1.5 (.08 - .1)
Red/White	2.3 - 3.9 (.16 - .27)	2.2 - 3.7 (.15 - .25)	2.2 - 3.7 (.15 - .25)	2.0 - 3.4 (.14 - .23)
White	3.0 - 5.0 (0.2 - .34)	3.0 - 5.0 (0.2 - 3.4)	3.0 - 5.0 (0.2 - 3.4)	3.0 - 5.0 (0.2 - 3.4)

\*Maximum outlet pressure available from a CL-34-1 is 5 PSIG.

CL34-2		
Pilot Spring	Range	
	PSIG*	(Bar)*
Brown	0.75 - 2.5	(0.05 - 0.17)
Purple	4.0 - 5.5	(0.28 - 0.38)
Green**	1.5 - 10	(0.10 - 0.69)
Black	5.0 - 14	(0.34 - 0.97)
Blue	9.0 - 30	(0.62 - 2.07)
Silver	25 - 60	(1.72 - 4.14)

CL34-2IM		
Pilot Spring	Range	
	PSIG*	(Bar)*
Purple	4.0 - 5.5	(0.28 - 0.38)
Green	1.0 - 8.0	(0.07 - 0.55)
Black	9.0 - 11	(0.62 - 0.76)
Green/White	7.0 - 17	(0.48 - 1.17)
Blue	14 - 25	(0.97 - 1.72)
Silver	29 - 60	(2.00 - 4.14)

\*The maximum recommended pressure differential and closing spring is based on 2:1 safety factor.

\*\*IM versions available with green closing spring only.

## ORIFICE DATA, WIDE OPEN FLOW COEFFICIENTS AND MAXIMUM PRESSURES

Orifice Size (inches)	K-Factor	Maximum Operating Inlet Pressure (PSIG)		Maximum Emergency Inlet Pressure	Maximum Emergency Outlet Pressure
		<1 PSIG Delivery Pressures	>1 PSIG Delivery Pressures	PSIG	PSIG
1/4	125	100	175	300	66
3/8	290	100	150	300	
3/8 IM	255	100	150	300	
1/2	500	75	150	300	
1/2 IM	445	75	150	300	
5/8	700	50	150	300	
5/8 IM	540	50	150	180	
3/4	900	50	150	225	
3/4 IM	615	50	75	120	
7/8	1200	30	150	170	

### OPERATING TEMPERATURE RANGE

- -20°F to 150°F
- Silicone valve seats available for applications below -20°F

### ADDITIONAL SPECIFICATIONS

Maximum Capacity	60,000 SCFH (see capacity tables)
Available Pilot Vent Sizes	3/4"
Loading Ring Position	
M & D Models	0 degrees
All Other Models	<50 PSIG inlet pressure: 15 degrees (6 notches)
	>50 PSIG inlet pressure: 21 degrees (8 notches)
Other Available Options	Seal wire to indicate unapproved tampering
	1/8" pipe plug tap on upstream side of valve body
	Pilot supply line filter (contact ROOTS Regulators, Owenton, KY)
	Stainless steel supply line fittings
	Internal monitor test tap

## CONSTRUCTION

ROOTS Regulators takes pride in delivering American made products with the utmost concern for safety, quality, and customer satisfaction.

### Construction material

Valve body	High tensile strength cast iron (ASTM A-126, Class A)
Orifice	Brass (standard), Aluminum available on main orifice only
Internal monitor orifice	Brass (ASTM B16, Alloy 360)
Valve seat	Buna-N or silicone (for temperatures below -20°F)
Valve stem	Plated steel (AISI 1215)
Valve stem bushing	Stainless steel
Lever pin	Stainless steel (Type 303)
Lever	Zinc and dichromate plated steel (AISI C1010)
Stem Guide	Stainless steel
Upper diaphragm plate	Zinc and dichromate plated steel (14 gage steel)
Lower diaphragm plate	Die cast aluminum (ASTM B-85 Alloy SC84A)
Diaphragm	Buna-N and nylon reinforcing fabric
Vent screen	Stainless steel
Adjustment ferrule	Plated steel
Main & pilot seal cap	Die cast aluminum (ASTM CS43A)
Diaphragm case	Die cast aluminum (ASTM B85 Alloy SC84A)

### VALVE BODY SIZES (INCHES)

Inlet	Outlet	Screwed (NPT)	Flanged (ASA 125)
1-1/4	1-1/4	X	---
1-1/4	1-1/2	X	---
1-1/4	2	X	---
1-1/2	1-1/2	X	---
1-1/2	2	X	---
2	2	X	X
3	3	---	X

Note X indicates that the valve body is available in that configuration.

# CORRECTION FACTORS FOR NON-NATURAL GAS APPLICATIONS

The CL34 may be used to control gases other than natural gas. To determine the capacity for gases other than natural gas, multiply the values within the capacity tables by a correction factor. The table below lists the correction factors for some of the more common gases:

Gas Type	Specific Gravity	Correction Factor (CF)
Air	1.00	0.77
Butane	2.01	0.55
Carbon Dioxide (Dry)	1.52	0.63
Carbon Monoxide (Dry)	0.97	0.79
Natural Gas	0.60	1.00
Nitrogen	0.97	0.79
Propane	1.53	0.63
Propane-Air-Mix	1.20	0.71

To calculate the correction factor for gases not listed in the table above, use the gases' specific gravity and insert it in the formula listed below:

$$\sqrt{\frac{SG_1}{SG_2}}$$

Correction Factor (CF) =

Where:

SG1 = Specific gravity of the gas in which the capacity is published.

SG2 = Specific gravity of the gas to be controlled.

## Wide Open Flow Calculations

For wide-open orifice flow calculations use the following equations:

For  $\frac{P_1}{P_2} < 1.89$  use:  $Q = K\sqrt{P_2(P_1 - P_2)}$

For  $\frac{P_1}{P_2} > 1.89$  use:  $Q = \frac{KP_1}{2}$

Where: P1 = Absolute Inlet Pressure (PSIA)

P2 = Absolute Outlet Pressure (PSIA)

Q = Flow Rate (SCFH)

K = Orifice Coefficient (SCFH/PSI)

# CL34 SERIES COMMERCIAL REGULATOR, MODELS 1, 2, 1M, AND 2M

Capacity Table (1% Absolute Droop\*) (see page 13 for IM models capacity data)

Capacities in 1000 SCFH (m<sup>3</sup>/hr) of 0.6 S.G.; base conditions of 14.7 PSIA and 60°F.

**Typical Capacity Info.**

<b>Manufacturer</b>	ROOTS Regulators
<b>Type and model</b>	CL34
<b>Regulator</b>	
Inlet size	2"
Outlet size	2"

		Orifice Size					
		1/4"	3/8"	1/2"	5/8"	3/4"	7/8"
2	7" w.c.	0.6 (17)	1.4 (40)	2.5 (71)	3.5 (99)	4.5 (127)	6.1 (173)
	11" w.c.	0.5 (14)	1.3 (37)	2.4 (68)	3.3 (93)	4.4 (125)	5.8 (164)
	1	0.4 (11)	1.1 (31)	1.9 (54)	2.7 (76)	3.5 (99)	4.5 (127)
	1.5	0.3 (8)	0.8 (23)	1.4 (40)	1.9 (54)	2.5 (71)	3.4 (96)
3	7" w.c.	0.79 (22)	1.8 (51)	3.1 (88)	4.4 (125)	5.5 (156)	7.5 (212)
	11" w.c.	0.78 (22)	1.7 (48)	3.0 (85)	4.3 (122)	5.4 (153)	7.3 (207)
	1	0.72 (20)	1.6 (45)	2.8 (79)	3.9 (110)	5.1 (144)	7.0 (198)
	2	0.5 (14)	1.1 (31)	2.0 (57)	2.8 (79)	3.6 (102)	4.8 (136)
5	7" w.c.	1.05 (30)	2.4 (68)	4.1 (116)	5.8 (164)	7.5 (212)	10 (283)
	11" w.c.	1 (28)	2.3 (65)	4.0 (113)	5.7 (161)	7.3 (207)	9.8 (278)
	1	0.9 (25)	2.2 (62)	3.9 (110)	5.4 (153)	7.0 (198)	9.3 (263)
	2	0.8 (23)	2.0 (57)	3.5 (99)	4.9 (139)	6.3 (178)	8.3 (235)
	3	0.7 (20)	1.7 (48)	2.9 (82)	4.1 (116)	5.3 (150)	7.0 (198)
10	7" w.c.	1.5 (42)	3.5 (99)	6.0 (170)	8.4 (238)	10.9 (309)	14.5 (411)
	11" w.c.	1.4 (40)	3.4 (96)	5.9 (167)	8.3 (235)	10.7 (303)	14.3 (405)
	1	1.4 (40)	3.4 (96)	5.8 (164)	8.2 (232)	10.5 (297)	14 (397)
	2	1.4 (40)	3.3 (93)	5.7 (161)	8.0 (227)	10.1 (286)	13.5 (382)
	5	1.2 (34)	2.8 (79)	4.9 (139)	6.9 (195)	8.9 (252)	11.7 (331)
	8	0.8 (23)	1.9 (54)	3.3 (93)	4.7 (133)	6.0 (170)	8.0 (227)
15	1 or less	1.8 (51)	4.2 (119)	7.2 (204)	10 (283)	13 (368)	17.5 (496)
	2	1.8 (51)	4.2 (119)	7.2 (204)	10 (283)	13 (368)	17 (482)
	5	1.7 (48)	4.0 (113)	6.9 (195)	9.7 (275)	12.5 (354)	16.7 (473)
	8	1.5 (42)	3.6 (102)	6.2 (176)	8.7 (246)	11 (312)	15 (425)
	10	1.3 (37)	3.1 (88)	5.5 (156)	7.7 (218)	9.9 (280)	13 (368)
	13	0.9 (25)	2.1 (59)	3.7 (105)	5.1 (144)	6.6 (187)	8.8 (249)
20	5 or less	2.1 (59)	4.9 (139)	8.5 (241)	12 (340)	15.4 (436)	20 (567)
	10	1.9 (54)	4.5 (127)	7.8 (221)	10.9 (309)	14 (397)	18.5 (524)
	15	1.5 (42)	3.5 (99)	6.0 (170)	8.5 (241)	10.8 (306)	14.5 (411)
	18	1.2 (34)	2.8 (79)	4.9 (139)	6.9 (195)	8.9 (252)	11.5 (326)
30	11 or less	2.7 (76)	6.3 (178)	11 (312)	15.4 (436)	19.8 (561)	26 (737)
	15	2.6 (74)	6.0 (170)	10.5 (297)	14.7 (416)	18.7 (530)	25 (708)
	20	2.3 (65)	5.4 (153)	9.3 (263)	13 (368)	18.7 (473)	22 (623)
	25	1.7 (48)	4.0 (113)	7.0 (198)	9.8 (278)	12.5 (354)	16.8 (476)
40	16 or less	3.3 (93)	7.8 (221)	13.5 (382)	18.8 (533)	24 (680)	32 (907)
	20	3.2 (91)	7.5 (212)	13 (368)	18 (510)	23 (652)	31 (878)
	30	2.6 (74)	6.0 (170)	10.5 (297)	14.7 (416)	18.7 (530)	25 (708)
	35	1.9 (54)	4.5 (127)	7.8 (221)	11 (312)	14 (397)	18.5 (524)

\*Individual regulator performance may vary from data shown.



Shaded area not recommended for <1 PSIG (69 mbar) outlet pressure.



# CL34 SERIES COMMERCIAL REGULATOR, MODELS 1, 2, 1M, 2M

## Capacity Table (1% Absolute Droop\*) continued

Capacities in 1000 SCFH (m<sup>3</sup>/hr) of 0.6 S.G.; base conditions of 14.7 PSIA and 60°F.

		Inlet Pressure (PSIG)	Outlet Pressure (PSIG)	Orifice Size					
				1/4"	3/8"	1/2"	5/8"	3/4"	7/8"
<b>Typical Capacity Info.</b>	<b>Manufacturer</b>	ROOTS Regulators							
	<b>Type and model</b>	CL34							
	Inlet size	2"							
	Outlet size	2"							
50	22 or less	4.0 (113)	9.3 (263)	16 (453)	22 (623)	28 (793)	38 (1076)		
	30	3.7 (105)	8.7 (246)	15 (425)	21 (595)	27 (765)	36 (1020)		
	40	2.9 (82)	6.7 (190)	11.5 (326)	16 (453)	21 (595)	28 (793)		
	45	2.1 (59)	4.9 (139)	8.5 (241)	12 (340)	15 (425)	20 (567)		
60	26 or less	4.6 (130)	10 (283)	18.5 (524)	25 (708)	33 (935)	44 (1246)		
	40	4.1 (116)	9.5 (269)	16.5 (467)	23 (652)	29 (822)	39 (1105)		
	50	3.1 (88)	7.3 (207)	12.5 (354)	17.5 (496)	22 (623)	30 (850)		
	55	2.3 (65)	5.4 (153)	9.3 (263)	13 (368)	16.5 (467)	22 (623)		
75	37 or less	5.5 (156)	12 (340)	21 (595)	29 (822)	38 (1076)	51 (1445)		
	40	5.3 (150)	12 (340)	21 (595)	29 (822)	38 (1076)	51 (1445)		
	50	5.0 (142)	11 (312)	20 (567)	28 (793)	36 (1020)	48 (1360)		
	60	4.0 (113)	9.6 (272)	16 (453)	23 (652)	30 (850)	40 (1133)		
100	50 or less	7.1 (201)	16 (453)	28 (793)	39 (1105)	51 (1445)	65 (1841)		
125	60 or less	8.0 (227)	20 (567)	34 (963)	48 (1360)	60 (1700)	80 (2266)		

\*Individual regulator performance may vary from data shown.

 Shaded area not recommended for <1 PSIG (69 mbar) outlet pressure.

# CL34 PERFORMANCE CURVES

## 5 PSIG Set Point

<b>Type and model</b>	CL34-2
Inlet size	2-inch NPT
Outlet size	2-inch NPT
Orifice size	1/2-inch

All test results are reported at a base of 14.7 PSIA at 60° F and with 0.6 S.G. gas.

Regulator set at 5 PSIG for relief and performance testing with 40 PSIG inlet pressure @ 200 SCFH flow rate.

## 15 PSIG Set Point

Inlet size	2-inch NPT
Outlet size	2-inch NPT
Orifice size	1/2-inch

All test results are reported at a base of 14.7 PSIA at 60° F and with 0.6 S.G. gas.

Regulator set at 5 PSIG for relief and performance testing with 40 PSIG inlet pressure @ 200 SCFH flow rate.

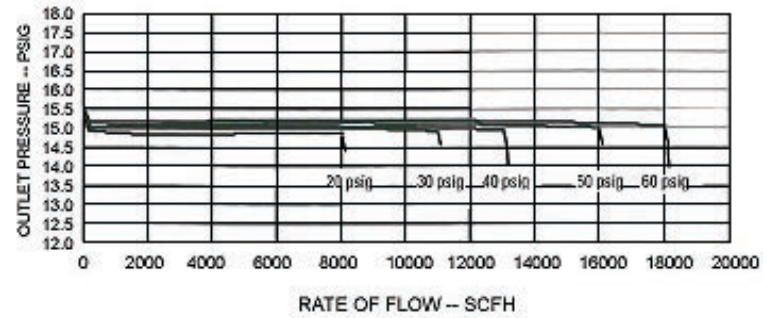
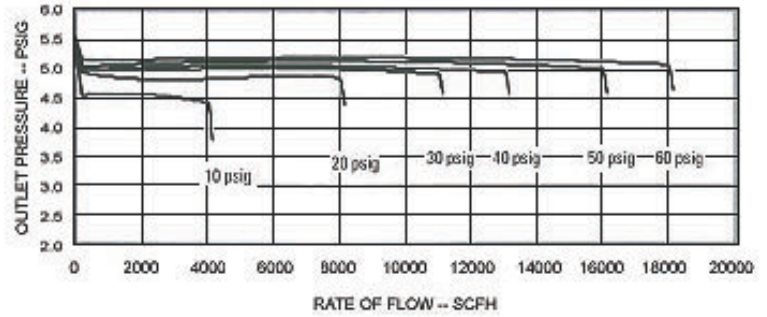

## CL34 INTERNAL MONITOR (IM)

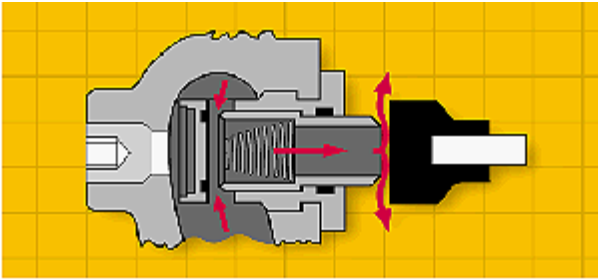

A. Standard regulator and upstream monitor orifice.

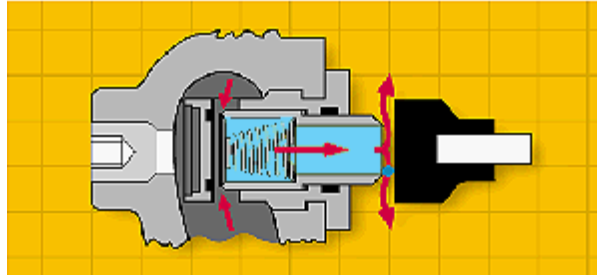

B. Standard regulator orifice failed; upstream monitor orifice control.

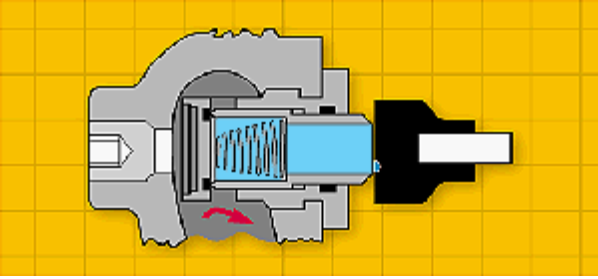

C. Main orifice failed - upstream monitor orifice lock-up.

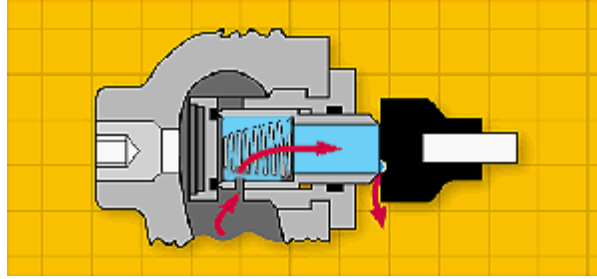

D. V option - vents a small volume of gas to atmosphere through relief valve.



## PRINCIPLE OF OPERATION

**A. Normal operation.** The internal monitor IM orifice performs like a standard regulator and monitor regulator in that main orifice and valve seat actuate to control outlet flow and pressure under normal flow conditions. If there is no demand, the main seat *and internal monitor orifice will close*.

**B. Monitor operation.** If the main valve seat fails to control the gas flow and pressure due to foreign matter between the seat and orifice face, or if the seat is eroded, the internal monitor orifice automatically goes into operating position at a slightly higher outlet pressure (see Internal Monitor Lock-up Pressure table). Any time the pressure on the main diaphragm exceeds the force of the fixed monitor spring, the increased outlet pressure causes the main valve seat to push against the sliding orifice. The sliding orifice compresses the monitor spring and positions the monitor orifice to control the gas flow. The IM orifice now functions as a monitor regulator and continues to monitor as long as the main seat fails to control at the normal adjusted outlet pressure. If the gas load demand is increased beyond the internal monitor's capacity, the outlet pressure is reduced to normal adjusted pressure and the regulator resumes normal regulation.

**C. Monitor lock-up.** If the demand for gas is decreased to zero flow during monitor operation, the sliding orifice continues to close until its orifice is in the gas tight position (monitor lock-up) against the BUNA-N monitor valve seat. (See the Internal Monitor Lock-up Pressure table for the outlet pressure required for internal monitor lock-up.)

**D. Vent hole V option.** On installations where a small volume of over-pressure gas can be safely vented to the atmosphere, the advantages of both the pilot relief valve and monitor safety can be combined. If the flow is decreased to zero or just greater than zero, the vent hole in the internal monitor orifice allows gas to slowly bleed downstream and cause the pressure to rise to the relief point of the pilot's internal relief valve. The gas then bleeds to the atmosphere indicating a problem with the regulator.

## INTERNAL MONITOR LOCK-UP PRESSURE\*

<b>With CL34-1 Pilot</b>		
<b>Outlet Pressure Set Point</b>	<b>Pilot Spring</b>	<b>IM Lock-up Pressure</b>
7" w.c.	Blue/White	15.0" w.c.
11" w.c.	Silver/White	19.0" w.c.
1 PSIG	Silver/White	1.3 PSIG
2 PSIG	Red/White	2.3 PSIG
3 PSIG	Red/White	3.4 PSIG
5 PSIG	White	5.5 PSIG
<b>With CL34-2 Pilot</b>		
1 PSIG	Green	1.4 PSIG
2 PSIG	Green	2.5 PSIG
3 PSIG	Green	3.5 PSIG
5 PSIG	Green	5.6 PSIG
8 PSIG	Green	8.6 PSIG
10 PSIG	Black	10.6 PSIG
10 PSIG	Green/white	10.6 PSIG
15 PSIG	Green/white	15.6 PSIG
15 PSIG	Blue	15.6 PSIG
20 PSIG	Blue	20.6 PSIG
25 PSIG	Blue	25.7 PSIG
30 PSIG	Silver	31.2 PSIG
35 PSIG	Silver	36.5 PSIG
40 PSIG	Silver	41.5 PSIG
50 PSIG	Silver	51.5 PSIG
60 PSIG	Silver	61.7 PSIG

Note The above tests were conducted using a 0.1-inch diameter nylon rod glued to the valve seat.

\*The internal monitor lock-up pressure refers to the outlet pressure necessary to close the internal monitor valve in the event there is no downstream demand.

# CL34 SERIES COMMERCIAL REGULATOR, MODELS 1IM AND 2IM

## Capacity Table (1% Absolute Droop\*)

Capacities in 1000 SCFH (m<sup>3</sup>/hr) of 0.6 S.G.; base conditions of 14.7 PSIA and 60°F.

Typical Capacity Info.		Orifice Size					
		Inlet Pressure PSIG	Outlet Pressure PSIG	3/8"	1/2"	5/8"	3/4"
<b>Manufacturer</b>	ROOTS Regulators	7" w.c.	1.3 (37)	2.3 (65)	2.8 (79)	3.1 (88)	
		11" w.c.	1.2 (34)	2.2 (62)	2.6 (74)	3.0 (85)	
<b>Type and model</b>	CL34-1IM, CL34-2IM	2	1	1.0 (28)	1.7 (48)	2.1 (59)	2.4 (68)
		2	1.5	0.7 (20)	1.3 (37)	1.5 (42)	1.7 (48)
		3	7" w.c.	1.6 (45)	2.8 (79)	3.5 (99)	3.9 (110)
		3	11" w.c.	1.5 (42)	2.7 (76)	3.4 (96)	3.8 (108)
5	1	1	1.4 (40)	2.5 (71)	3.1 (88)	3.6 (102)	
		2	1.0 (28)	1.8 (51)	2.2 (62)	2.5 (71)	
		5	7" w.c.	2.2 (62)	3.7 (105)	4.6 (130)	5.2 (147)
		5	11" w.c.	2.1 (59)	3.6 (102)	4.5 (127)	5.1 (144)
10	1	2	2.0 (57)	3.5 (99)	4.3 (122)	4.9 (139)	
		2	1.8 (51)	3.1 (88)	3.9 (110)	4.4 (125)	
		3	1.5 (42)	2.6 (74)	3.3 (93)	3.7 (105)	
		7" w.c.	3.2 (91)	5.4 (153)	6.7 (190)	7.6 (215)	
		10	11" w.c.	3.1 (88)	5.3 (150)	6.6 (187)	7.5 (212)
		10	1	3.1 (88)	5.2 (147)	6.5 (184)	7.4 (210)
15	1	2	3.0 (85)	5.1 (144)	6.4 (181)	7.1 (201)	
		5	2.5 (71)	4.4 (125)	5.5 (156)	6.2 (176)	
		8	1.7 (48)	3.0 (85)	3.8 (108)	4.2 (119)	
		1 or less	3.8 (108)	6.5 (184)	8.0 (227)	9.1 (258)	
		2	3.8 (108)	6.5 (184)	8.0 (227)	9.1 (258)	
		5	3.6 (102)	6.2 (176)	7.8 (221)	8.8 (249)	
20	1	8	3.2 (91)	5.6 (159)	7.0 (198)	7.7 (218)	
		10	2.8 (79)	5.0 (142)	6.2 (176)	6.9 (195)	
		13	1.9 (54)	3.3 (93)	4.1 (116)	4.6 (130)	
		5 or less	4.4 (125)	7.7 (218)	9.6 (272)	10.8 (306)	
20	1	10	4.1 (116)	7.0 (198)	8.7 (246)	9.8 (278)	
		15	3.2 (91)	5.4 (153)	6.8 (193)	7.6 (215)	
		18	2.5 (71)	4.4 (125)	5.5 (156)	6.2 (176)	

Notes:

\*Individual regulator performance may vary from data shown.

# CL34 SERIES COMMERCIAL REGULATOR, MODELS 1IM AND 2IM

## Capacity Table (1% Absolute Droop\*) continued

Capacities in 1000 SCFH (m<sup>3</sup>/hr) of 0.6 S.G.; base conditions of 14.7 PSIA and 60°F.



### Typical Capacity Info.

<b>Manufacturer</b>	ROOTS Regulators
<b>Type and model</b>	CL34-1IM, CL34-2IM

Inlet Pressure PSIG	Outlet Pressure PSIG	Orifice Size			
		3/8"	1/2"	5/8"	3/4"
30	11 or less	5.7 (161)	9.9 (280)	12.3 (348)	13.9 (394)
	15	5.4 (153)	9.5 (269)	11.8 (334)	13.1 (371)
	20	4.9 (139)	8.4 (238)	10.4 (295)	11.7 (331)
	25	3.6 (102)	6.3 (178)	7.8 (221)	8.7 (246)
40	16 or less	7.0 (198)	12.2 (346)	15.0 (425)	16.8 (476)
	20	6.8 (193)	11.7 (331)	14.4 (408)	16.1 (456)
	30	5.4 (153)	9.5 (269)	11.8 (334)	13.1 (371)
	35	4.1 (116)	7.0 (198)	8.8 (249)	9.8 (278)
50	22 or less	8.4 (238)	14.4 (408)	17.6 (499)	19.6 (555)
	30	7.8 (221)	13.5 (382)	16.8 (476)	18.9 (535)
	40	6.0 (170)	10.3 (292)	12.8 (363)	14.7 (416)
	45	4.4 (125)	7.6 (215)	9.6 (272)	10.5 (297)
60	26 or less	9.0 (255)	16.6 (470)	20.0 (567)	23.0 (652)
	40	8.5 (241)	14.9 (422)	18.4 (521)	20.3 (575)
	50	6.6 (187)	11.2 (317)	14.0 (397)	15.4 (436)
	55	4.9 (139)	8.4 (238)	10.4 (295)	11.5 (326)
75	37 or less	10.8 (306)	18.9 (535)	23.2 (657)	26.6 (754)
	40	10.8 (306)	18.9 (535)	23.2 (657)	26.6 (754)
	50	9.9 (280)	18.0 (510)	22.4 (635)	25.2 (714)
	60	8.6 (244)	14.4 (408)	18.4 (521)	21.0 (595)
100	50 or less	14.4 (408)	25.0 (708)	31.0 (878)	
125	60 or less	18.0 (510)	31.0 (878)	38.0 (1076)	

Notes:

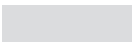
\*Individual regulator performance may vary from data shown.

-  Shaded area not recommended for <1 PSIG (69 mbar) outlet pressure.
-  Do not operate orifice in shaded inlet pressure area.

# ASSEMBLY POSITIONS



**POSITION 1A**

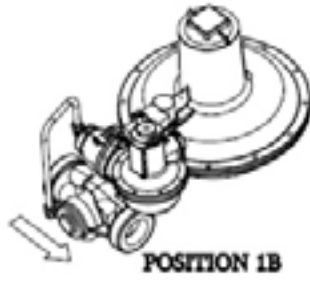

**POSITION 1B**

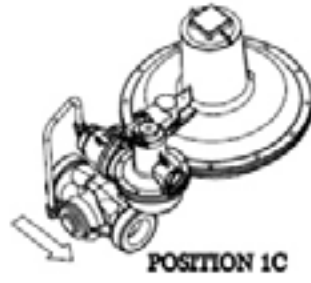

**POSITION 1C**

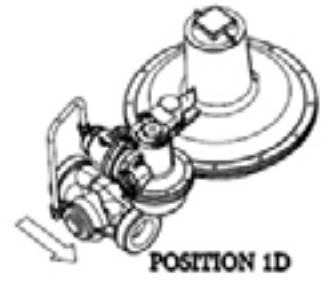

**POSITION 1D**

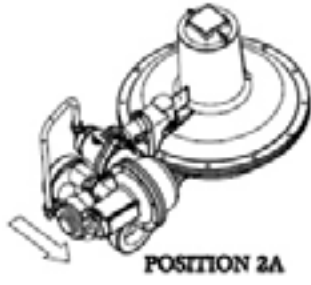

**POSITION 2A**

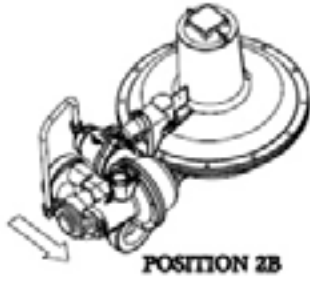

**POSITION 2B**

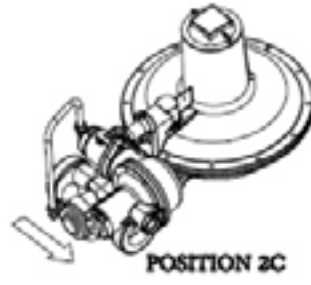

**POSITION 2C**

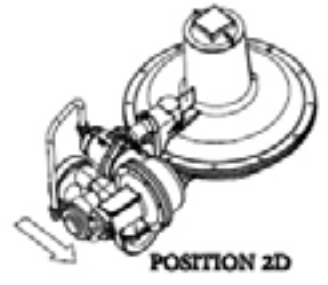

**POSITION 2D**

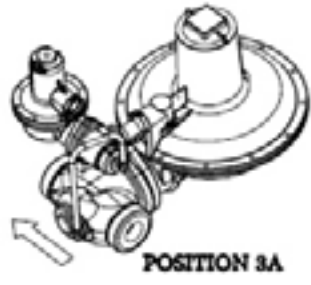

**POSITION 3A**

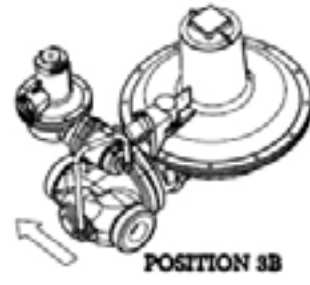

**POSITION 3B**

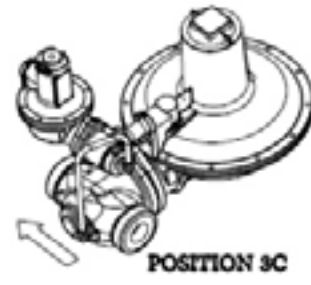

**POSITION 3C**

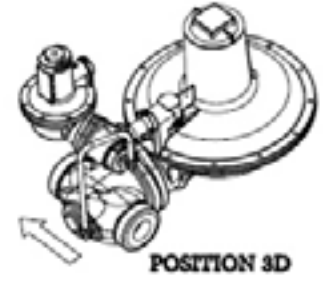

**POSITION 3D**

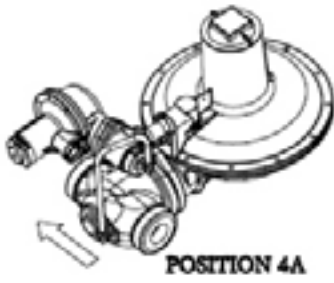

**POSITION 4A**

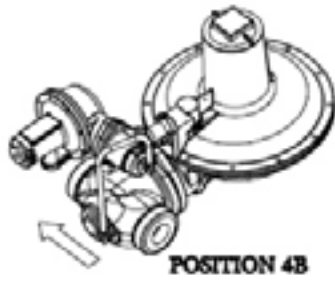

**POSITION 4B**

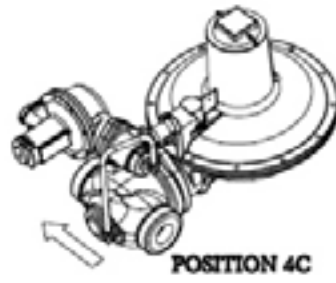

**POSITION 4C**

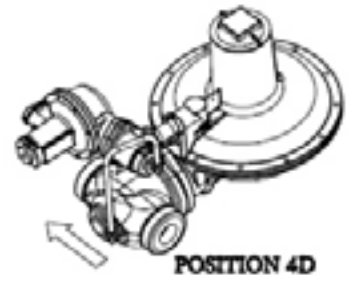

**POSITION 4D**

# PARTS LIST SCHEMATIC

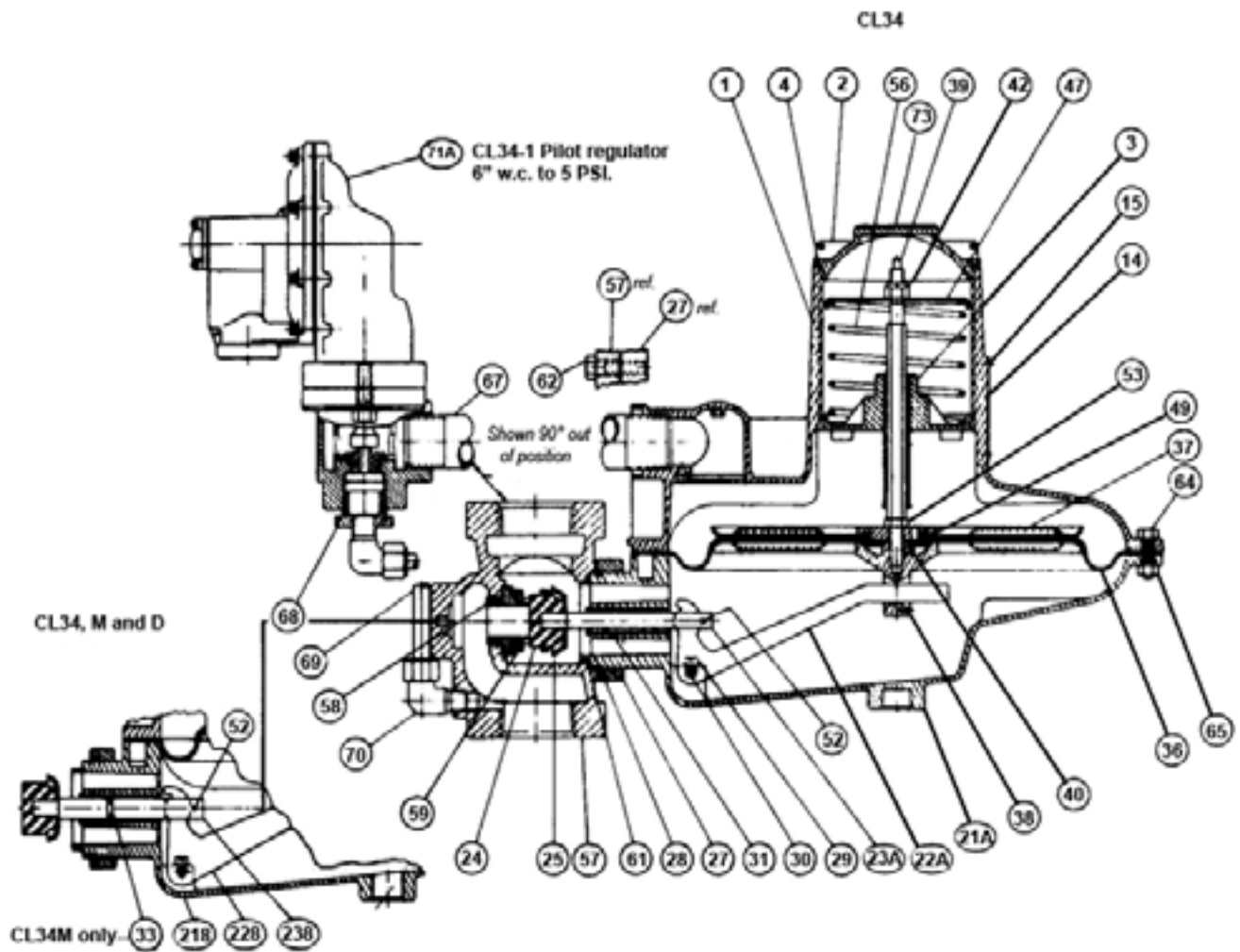

## CL34 PARTS LIST

Model CL34-1, 2, M1, M2, D1, D2, and 1IM and 2IM

Item Number	Part Number	Quantity per regulator			Description
		CL34	CL34D	CL34M	
1	753418	1	1	1	Upper diaphragm case
2	760084	1	1	1	Seal cap
3	736011	1	1	1	Adjustment screw guide assembly
4	765607	1	1	1	Seal cap gasket
14	769250	1	1	1	Regulator badge
15	755071	2	2	2	Badge drive screw
21A	715050	1			Lower diaphragm case, 4:1 ratio-open throat
21B	715052		1	1	Lower diaphragm case 3:5:1 ratio-closed throat
22A	761275	1			Valve linkage lever 4:1 ratio
22B	761271		1	1	Valve linkage lever 3:5:1 ratio
23A	754151	1			Valve stem 3/8" square
23B	754154		1	1	Valve stem 17/32" diameter O-ring groove
24					Valve seat
	765203	1	1	1	With white-stripe (standard) Buna "N", 85 Durometer
	765251				With yellow stripe for IM test tap version only



Item Number	Part Number	Quantity per regulator			Description
		CL34	CL34D	CL34M	
25					Deflector ring
	761723	1			Internal monitor version
	761721	1	1	1	Standard version (non-IM versions)
27	751913	1	1	1	Valve body retainer plate
28	755725	1	1	1	Retainer plate snap ring
29	755223	2	2	2	Valve linkage pin screw
30	754836	1	1	1	Valve linkage pin
31	754211	1	1	1	Valve stem bushing
33	765505			1	Valve stem O-ring
36	766301	1	1	1	Diaphragm
37	76104102	2	2	2	Upper diaphragm plate
38	756077	1	1	1	Lower diaphragm plate
39	754361	1	1	1	Stop stem
40	755115	1	1	1	Set screw
42	755671	1	1	1	Stop stem locknut
47	761471	1	1	1	Closing spring guide
49	761083	1	1	1	Secondary diaphragm plate
52A	755007	1	-	-	Valve stem slot pin 3/32" diameter x 3/8" long
52B	755009	-	1	1	Valve stem slot pin 3/32" diameter x 3/8" long
53	755531	1	1	1	Diaphragm nut steel
56		1	1	1	Closing spring, please specify
	762341				Orange
	762351				Brown
	762353				Green
	762355				Black
57		1	1	1	Valve body, please specify type (NPT screwed versions) & size
	750610				1-1/4" x 1-1/4" with 1/4" NPT pilot supply tap
	750633				1-1/4" x 1-1/2" with 1/4" NPT pilot supply tap
	750660				1-1/4" x 2" with 1/4" NPT pilot supply tap
	750683				1-1/4" x 1-1/4" NPT with 1/4" NPT pilot supply tap
	750686				1-1/2" x 1-1/2" with IM test tap
	750688				1-1/2" x 1-1/2" with BSPT 1/8" tap
	750710				1-1/4" x 2" with 1/4" NPT pilot supply tap
	750733				2" x 2" with 1/4" NPT pilot supply tap
	750734				2" x 2" with 1/4" NPT pilot supply tap
	750736				2" x 2" with IM test tap
	750738				2" x 2" BSP with IM test tap
	750760				2" x 2" NPT with 1/4" NPT pilot supply tap
		1	1	1	Valve body, please specify type (ANSI 125 flat-face flanged versions) & size
	750760				2" ASA, 10" length with pilot supply tap
	750766				2" ASA, 10" length with IM test tap
	750783				2" ASA, 7.5" length with 1/4" NPT pilot supply tap
	750810				3" A.S.A. 1/4" NPT pilot supply tap

Item Number	Part Number	Quantity per regulator			Description
		CL34	CL34D	CL34M	
58A		1	1	1	Orifice, brass, please specify size
					Straight
	758101				1/4" diameter
	758104				3/8" diameter
	758107				1/2" diameter
	758110				5/8" diameter
	758113				3/4" diameter
	758117				7/8" diameter
					Tapered
	758169				7/8" x 1" diameter
58B		1			Internal monitor orifice assemblies (for more information, see IM Orifice Assembly on page 21)
	759121				3/8" IM
	759123				1/2" IM
	759125				5/8" IM
	759127				3/4" IM
	759131				3/8" IM vented
	759133				1/2" IM vented
	759135				5/8" IM vented
	759137				3/4" IM vented
	759141				3/8" IM with test tap
	759143				1/2" IM with test tap
	759145				5/8" IM with test tap
	759147				3/4" IM with test tap
59	761761	1	1	1	Loading ring (including IM versions)
61	765651	1	1	1	Valve body gasket
62	755381	2	2	2	Retainer plate screw hex head steel 5/16"-18 x 1-1/4" cadmium plate
64	755311	12	12	12	Case screw hex head cadmium plate steel 1/4"- 20 x 1"lg.
65	755513	10	10	10	Case screw nut
67	768143	1	1	1	Nipple, 1" NPT x 2" long
68	768203	1	1	1	Reducing bushing 1/4" female x 3/4" male
69	768513	1	1	1	Control line stainless steel; 3/8" diameter
70	768263	2	2	2	90" elbow male tube fitting 3/8" tube x 1/4" NPTF
71A		1	1	1	-1 Pilot sub-assemblies
	700100-1				CL34-1 pilot with green/white spring
	700100-2				CL34-1 pilot with blue/white spring
	700100-3				CL34-1 pilot with dark green spring
	700100-4				CL34-1 pilot with silver/white spring
	700100-5				CL34-1 pilot with yellow/white spring
	700100-6				CL34-1 pilot with red/white spring
	700100-7				CL34-1 pilot with white spring
	700100-8				CL34-1 pilot with silver spring

Item Number	Part Number	Quantity per regulator			Description
		CL34	CL34D	CL34M	
71B		1	1	1	-2 Pilot sub-assemblies with brown relief spring unless otherwise noted)
	700200-1				CL34-2 pilot w/brown spring
	700200-12				CL34-2 pilot w/green spring and green relief spring
	700200-2				CL34-2 pilot with green spring
	700200-3				CL34-2 pilot with black spring
	700200-4				CL34-2 pilot with blue spring
	700200-5				CL34-2 pilot with silver spring
	700200-6				CL34-2 pilot with green/white spring
73	769401	1	1	1	Warning sticker

Special Tools	
799081	Loading ring positioning tool
799051	Spring adjustment wrench (pilot only)
800007	Seal wire, no lead (specify quantity of 2)
799021	Thin wall orifice socket

Torque Specifications	
Retainer plate screws	100 in. lbs
Orifice	600 in. lbs
Orifice	(IM & SO) 300 in. lbs
Margin screws	30 in. lbs

CL34-1 PILOT REFERENCE SCHEMATIC (SEE MAIN PARTS LIST ITEM 71A FOR PILOT SUB-ASSEMBLIES)

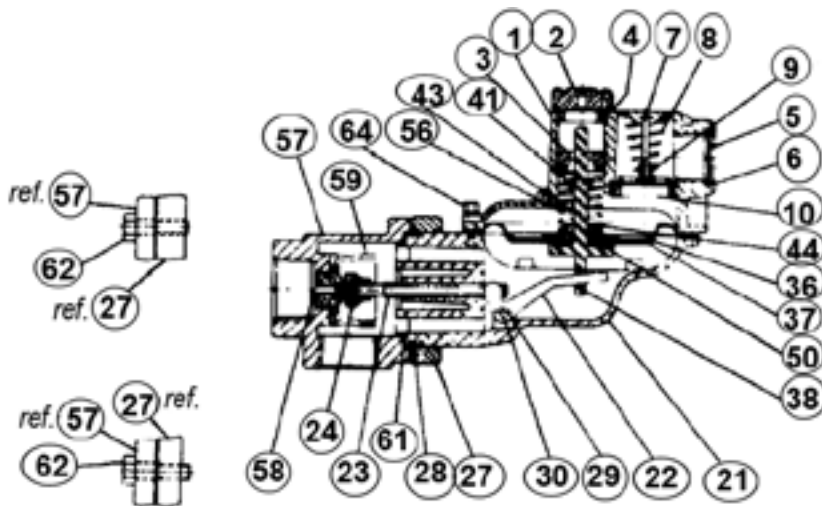

CL34-1 PILOT PARTS LIST

Item Number	Part Number	Quantity	Description
1	753027	1	Upper diaphragm case 3/4" NPT vent
2	760053	1	Seal cap
3	760217	1	Adjustment screw aluminum
4	765771	1	Seal cap gasket
5	762935	1	Vent screen wire mesh
6	75572701	1	Vent screen retaining ring
7	754806	1	Vent screen disc pin

8	762601	1	Vent valve spring
9	765181	1	Vent valve disc
10	765685	1	Vent valve seat
21	752014	1	Lower diaphragm case
22	761201		Valve linkage lever
23	754021	1	Valve stem aluminum
24	765021	1	Valve seat, Buna "N" 75 Duro
27	751913	1	Valve body retainer plate
28	755725	1	Retainer plate snap ring
29	755141	2	Valve linkage pin screw
30	754831	1	Valve linkage pin
38	766010	1	Diaphragm
37	761001	1	Upper diaphragm plate
38	756021	1	Lower diaphragm plate
41	761401	1	Relief spring guide
43	762051	1	Relief spring-relief point 7" w.c. above set
44	754905	1	Stop stem guide bushing
50	765755	1	Relief valve seal gasket
56		1	Adjustment spring
	762007		Green/white
	762013		Blue/white
	762117		Dark green
	762017		Silver/white
	762021		Yellow/white
	762027		Red/white
	762029		White
	762034		Yellow/blue
	762650		Yellow/black
57	750044	1	90° Valve body 3/4" x 1" NPT
58	757255	1	Orifice 1/8" diameter brass
59	761753	1	Loading ring
61	765751	1	Valve body gasket flat
62	755371	2	Retainer plate screw hex head steel 5/16" x 18 x 1-1/8" cadmium plated
64	755221	8	Case screw hex washer head steel; #8 32 x 13/16" cadmium plated

CL34-2 PILOT REFERENCE SCHEMATIC (SEE MAIN PARTS LIST ITEM 71B FOR PILOT SUB-ASSEMBLIES)

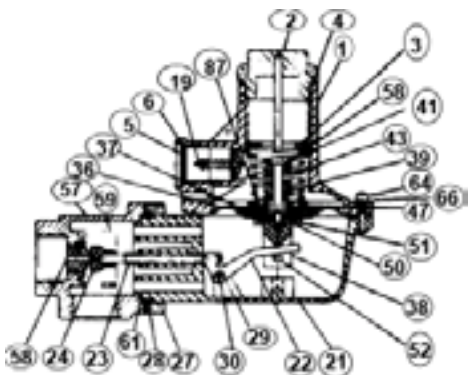

## CL34-2 PILOT PARTS LIST

Item Number	Part Number	Quantity	Description
1	753044	1	Upper diaphragm case 3/4" NPT vent
2	730003	1	Seal cap assembly
3	760201	1	Adjustment screw
4	765603	1	Seal cap gasket
5	762905	1	Vent screen spiral
6	75572701	1	Vent screen retaining ring
19	730101	1	Vent valve assembly
21	752311	1	Lower diaphragm case
22	761201	1	Valve linkage lever
23	754021	1	Valve stem
24	765021	1	Valve seat Buna "N" 75 Duro
27	751955	1	Valve body retainer plate
28	755725	1	Retainer plate snap ring
29	755141	2	Valve linkage pin screw
30	754832	1	Valve linkage pin
36	766031	1	Diaphragm
37	761011	1	Upper diaphragm plate
38	756001	1	Lower diaphragm plate
39	755191	1	Stop stem - steel
41	761411	1	Relief spring guide
43	762081	1	Relief spring, brown 1.5 PSIG above set
47	761421	1	Adjustment spring guide
50	765711	1	Relief valve seal gasket
51	756005	1	Diaphragm plate screw
52	755001	1	Rollpin
56		1	Adjustment spring
	762401		Brown
	762403		Green
	762405		Black
	762407		Blue
	762409		Silver
57	750044	1	90° Valve body 3/4" x 1" NPT
58	757255	1	Orifice 1/8" diameter, brass
59	761753	1	Loading ring
61	765753	1	Valve body gasket
62	755371	2	Retainer plate screw hex head steel 5/16" x 18 x 1-1/8" cadmium plated
64	755175	8	Case screw-socket head #10 - 24 x 7/8" steel cadmium plated
66	755855	8	Lock washer
67	755821	1	Washer, anti-friction

## IM ORIFICE ASSEMBLY

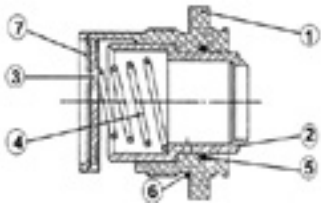

## IM ORIFICE ASSEMBLY PARTS LIST

Complete Assembly Part Numbers					Item	Description	Part Number
759119	759121	759123	759125	759127			
Quantity							
1					9	1/4" diameter sliding orifice	758233
	1				9	3/8" diameter sliding orifice	758235
		1			9	1/2" diameter sliding orifice	758238
			1		9	5/8" diameter sliding orifice	758241
				1	9	3/4" diameter orifice, stepped	758231
1	1	1	1	1	8	O-ring	765501
1	1	1	1	1	7	Monitor seat	765741
1	1	1	1	1	6	Soc.fl. head screw	755131
1	1	1	1	1	5	Anchor	756103
1	1	1	1	1	4	O-ring	765509
1	1	1	1	1	3	Anchor plate	754511
1	1	1	1	1	2	Cut-off spring	762311
1	1	1	1	1	1	Stationary orifice	758221

## IM ORIFICE ASSEMBLY WITH VENT HOLE "V" OPTION

Complete Assembly Part Numbers					Item	Description	Part Number
759129	759131	759133	759135	759137			
Quantity							
1					9	1/4" diameter sliding orifice with "v"	758253
	1				9	3/8" diameter sliding orifice with "v"	758255
		1			9	1/2" diameter sliding orifice with "v"	758258
			1		9	5/8" diameter sliding orifice with "v"	758261
				1	9	3/4" diameter sliding orifice with "v"	758251
1	1	1	1	1	8	O-ring	765501
1	1	1	1	1	7	Monitor seat	765741
1	1	1	1	1	6	Socket flat-head screw	755131
1	1	1	1	1	5	Anchor	756103
1	1	1	1	1	4	O-ring	765509
1	1	1	1	1	3	Anchor plate	754511
1	1	1	1	1	2	Cut-off spring	762311
1	1	1	1	1	1	Stationary orifice	758221

## VENT LINES FOR REGULATORS

When constructing vent lines to be attached to regulators installed indoors, follow a few basic rules:

- a. Never use pipe sizes smaller than the vent size; smaller pipe sizes restrict the gas flow. If a long gas run must be used, ROOTS Regulators advises increasing the pipe one nominal size every ten feet to keep the flow restriction as low as possible.
- b. Keep the vent line length as short as possible to minimize the restriction and reduce the vent's tendency to cause regulator pulsation.
- c. Support the vent pipe to eliminate strain on the regulator diaphragm case.
- d. Always point outdoor vent pipes in the downward position to reduce the possibility of rain, snow, sleet, and other moisture entering the pipe. Install a bug screen in the end of the pipe.
- e. Do not locate the vent line terminus near windows, fans, or other ventilation equipment. See the installation instructions furnished with the regulator.
- f. Adhere to all applicable codes and regulations.
- g. If your vent pipe causes regulator pulsation, consult your sales representative or manufacturer.
- h. ROOTS Regulators strongly recommends running a separate vent line for each regulator. Headers with various installed devices can cause regulator malfunction.

---

**Caution** Ensure the end of the vent line is away from ANY potential ignition sources. It is the installer's responsibility to ensure the vent line is exhausting to a safe environment.

---

## INSTALLATION

---

**Warning** ROOTS Regulators does not endorse or warrant the completeness or accuracy of any third party regulator installation procedures or practices, unless otherwise provided in writing by ROOTS Regulators. Follow your company's standard operating procedures regarding the use of personal protection equipment (PPE). Adhere to guidelines issued by your company in addition to those given in this document when installing regulators.

---

- a. Remove all shipping plugs from the regulator inlet, outlet, and vent before installation.
- b. Verify the piping interior and regulator inlet and outlet are clean and free of dirt, pipe dope, and other debris. Dirt and other foreign materials entering the regulator can cause a loss of pressure control.
- c. Apply pipe joint sealant to the male pipe threads. Do not use pipe joint material on the regulator's female threads. Joint sealant could become lodged in the regulator and cause a loss of pressure control.
- d. Gas must flow through the regulator's valve body in the direction cast on the regulator body. Gas flowing in the wrong direction can overpressure and cause damage to the regulator.
- e. The pilot diaphragm casing can be mounted in any position relative to the body through a full 360° angle at 90° increments.
- f. When the regulator is installed OUTDOORS, the vent must always be positioned so that rain, snow, moisture or foreign particles cannot enter the vent opening. ROOTS Regulators recommends positioning the pilot vent downward to avoid entry of water or other matter which could interfere with the proper operation of the regulator. The vent should be located away from building eaves, window openings, building air intakes and above the expected snow level at the site. The vent opening should be inspected periodically to insure it does not become blocked by foreign material as outlined in DOT PHMSA-RSPA-2004-19856.
- g. When the regulator is installed INDOORS, the vent must be piped to the outside atmosphere using the shortest length of pipe, the fewest possible pipe elbows, and a pipe diameter as large as the vent size or larger. USING VENT PIPE SMALLER THAN THE VENT CONNECTION LIMITS THE REGULATOR'S INTERNAL RELIEF VALVE CAPACITY. The outlet end of the pipe must be protected from moisture and the entrance of foreign particles. The regulator should be specified by the user with the size vent and pipe threads desired to make the vent pipe connection.

## START-UP PROCEDURE

- a. Mount a pressure gauge downstream of the regulator to monitor the downstream pressure.
- b. With the downstream pressure valve closed, slowly open the inlet valve. The outlet pressure should rise to slightly more than the setpoint. Verify there are no leaks and all connections are tight.
- c. The regulator was pre-set at the factory to match order specifications. If necessary, adjust the outlet pressure by removing the seal cap on the top of the pilot spring housing and adjusting the ferrule or screw inside the pilot spring housing using a large flat-head screwdriver. With a small amount of gas flowing through the regulator, rotate the pilot ferrule clockwise to raise the outlet pressure or counter-clockwise to lower the outlet pressure.
- d. Replace the seal cap and check for leaks after the desired outlet pressure is achieved.

The regulator is ready for operation.

## CL34 OPERATOR AND MONITOR INSTALLATION SCHEMATIC

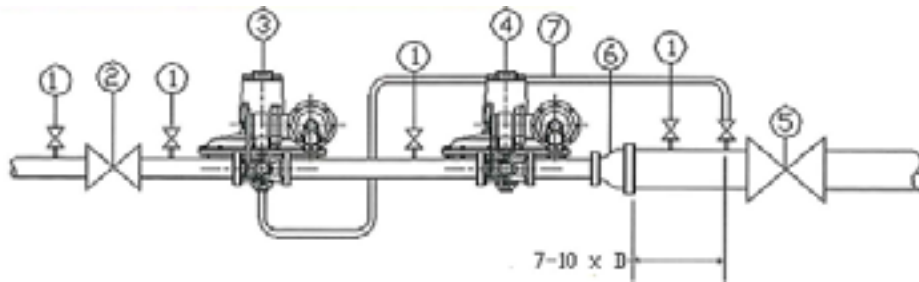

1. Gage tap shut-off valve
2. Upstream isolation valve
3. Model CL34IM
4. Model CL34
5. Downstream isolation valve
6. Reducer (minimum 1 pipe size larger than regulator valve body)
7. Downstream sensing line (1/2" minimum)

## OPERATOR/MONITOR START-UP PROCEDURE

- a. Mount a pressure gauge between the downstream regulator (4) and the downstream shut-off valve(5) to monitor the downstream pressure.
- b. With the downstream pressure valve closed, slowly open the upstream shut off valve (2).The outlet pressure should rise to slightly more than the set-point. Verify there are no leaks and all connections are tight.
- c. Monitor the set-point adjustment
  1. To adjust the monitor's set-point, induce some amount of flow through both regulators. (CL series regulators are set at the factory with 200 SCFH of 0.6 S.G. gas.)
- d. Remove the operator's pilot spring cap (do not remove main spring cap). Using a large flat-head screwdriver, slowly rotate the threaded adjustment ferrule clockwise. Continue to rotate the ferrule until the outlet pressure is greater than the desired monitor set pressure. In some cases, this may require the temporary use of a heavier pilot spring.
- e. Remove the monitor's pilot spring cap (do not remove the main spring cap). Rotate the adjustment ferrule until the desired monitor set pressure is reached (rotate the adjustment ferrule clockwise to increase pressure; rotate the adjustment ferrule counter-clockwise to decrease pressure).
- f. Decrease the flow through both regulators to zero then return the flow to the previous value. If the downstream pressure has changed from the desired value, repeat previous step. Replace the monitor's pilot spring cap.
- g. Operator set-point adjustment:
  1. To adjust the operator's set-point, rotate the adjustment ferrule counter-clockwise until the desired downstream operator set pressure is reached.
- h. Decrease the flow through both regulators to zero then return the flow to the previous value. If the downstream pressure changed from the desired value, repeat the previous step. Replace the operator's pilot spring cap.
- i. Both regulators are now set for continuous operation.

## MONITOR FIELD CHECK

- a. To check the monitor regulator's operation, remove the operator's pilot spring cap.
- b. Push down on the pilot stem until the downstream pressure rises to the monitor's set-point. The monitor will begin throttling, assuring its proper operation. If the pressure continues to rise above the monitor set-point, the monitor is not functioning properly. Consult the ROOTS Regulators Owenton KY factory, if necessary.

## SAFETY WARNING

This product, as of the date of manufacture, is designed and tested to conform to all governmental and industry safety standards as they may apply to the manufacturer. The purchaser/user of this product must comply with all fire control, building codes, and other safety regulations governing the application, installation, operation, and general use of this regulator to avoid leaking gas hazards resulting from improper installation, startup or use of this product.

ROOTS Regulators strongly recommends installation by a qualified professional and periodic inspection of pressure regulators (inspections may be required by local applicable codes or regulations).

Inspections should include checking for gas quality, cycle numbers, external environmental changes, and operating conditions that impact wear on the regulator's moving parts. To ensure safe and efficient operation of this product, replace worn or damaged parts found during inspection.



## Limited Warranty

ROOTS Regulators are subject to the terms and conditions of the Natural Gas Solutions North America, LLC General Terms & Conditions For Sale of Products, Parts and Services, and no other terms shall apply, unless agreed upon by the parties in writing. The Natural Gas Solutions North America, LLC General Terms & Conditions For Sale of Products, Parts and Services can be found on the Dresser Utility website: [dresserutility.com/forms-questionnaires-and-terms-conditions-sale](http://dresserutility.com/forms-questionnaires-and-terms-conditions-sale).

## Ordering Information

Specify:

1. Inlet and Outlet Connection Size and Type
2. Model Number
3. Outlet pressure desired
4. Pilot needed
5. Inlet pressure range
6. Type of gas and maximum capacity required
7. Assembly position number (see chart below)
8. Special requirements such as tagging, 1/8" pipe plug tap, seal wire, etc.

### ROOTS Regulators

16240 Port Northwest Drive  
Houston, TX 77041  
T: 1-800-521-1114  
F: 1-800-335-5224

© 2022 Natural Gas Solutions North America, LLC – All rights reserved. Dresser Utility Solutions reserves the right to make changes in specifications and features shown herein, or discontinue the product described at any time without notice or obligation. Contact your Dresser Utility Solutions representative for the most current information. The Dresser Logo and all Trademarks containing the term "Dresser" are the property of Dresser, LLC, a subsidiary of Baker Hughes.

